

# TIME - INDEPENDENT PERTURBATION THEORY

6.1

## ⇒ NON DEGENERATE PERTURBATION THEORY

### • INTRO

↳ SUPPOSE WE HAVE SOLVED

$$H^0 |\psi_m^0\rangle = E_m^0 |\psi_m^0\rangle$$

(UNPERTURBED PROBLEM)

↳ SUPPOSE WE WANT TO SOLVE SCHRÖDINGER EQ. H ATOM. IN  
IN PRESENCE OF SMALL PERTURBATION (e.g. WEAK APPLIED  
MAGNETIC FIELD)

$$H = H^0 + \lambda H^1$$

↑  
SMALL PERTURBATION

( $\lambda$  PARAMETER TO DENOTE  
ORDER OF PERTURBATION

WILL BE TAKEN  $\rightarrow 1$  IN END)

$$H |\psi_m\rangle = E_m |\psi_m\rangle$$

CAN WE FIND APPROXIMATE SOLUTIONS

FOR  $|\psi_m\rangle$  &  $E_m$  ?

$$|\Psi_m\rangle = |\Psi_m^0\rangle + \lambda |\Psi_m^1\rangle + \lambda^2 |\Psi_m^2\rangle + \dots$$

$$E_m = E_m^0 + \lambda E_m^1 + \lambda^2 E_m^2 + \dots$$

$\uparrow$                        $\uparrow$                        $\uparrow$   
 KNOWN                      1-ORDER CORRECTION                      2-ORDER CORRECTION

$$\downarrow \quad H|\Psi_m\rangle = E_m|\Psi_m\rangle$$

$$(H^0 + \lambda H^1) (|\Psi_m^0\rangle + \lambda |\Psi_m^1\rangle + \lambda^2 |\Psi_m^2\rangle + \dots)$$

$$= (E_m^0 + \lambda E_m^1 + \lambda^2 E_m^2 + \dots) (|\Psi_m^0\rangle + \lambda |\Psi_m^1\rangle + \lambda^2 |\Psi_m^2\rangle + \dots)$$

$\downarrow$  EXPANSION IN  $\lambda$

$$H^0|\Psi_m^0\rangle + \lambda (H^1|\Psi_m^0\rangle + H^0|\Psi_m^1\rangle) + \lambda^2 (H^1|\Psi_m^1\rangle + H^0|\Psi_m^2\rangle) + \dots$$

$$= E_m^0|\Psi_m^0\rangle + \lambda (E_m^1|\Psi_m^0\rangle + E_m^0|\Psi_m^1\rangle) + \lambda^2 (E_m^0|\Psi_m^2\rangle + E_m^1|\Psi_m^1\rangle + E_m^2|\Psi_m^0\rangle) + \dots$$

$\downarrow$  IDENTIFY TERMS IN  $\lambda$ -EXPANSION

↳ TO LOWEST ORDER  $\lambda^0$  :

$$H^0 |\psi_m^0\rangle = E_m^0 |\psi_m^0\rangle$$

ORIGINAL, UNPERTURBED PROBLEM WHICH WE HAVE SOLVED

↳ TO FIRST ORDER  $\lambda^1$  :

$$H^1 |\psi_m^0\rangle + H^0 |\psi_m^1\rangle = E_m^1 |\psi_m^0\rangle + E_m^0 |\psi_m^1\rangle$$

↳ TO SECOND ORDER  $\lambda^2$  :

$$H^1 |\psi_m^1\rangle + H^0 |\psi_m^2\rangle = E_m^0 |\psi_m^2\rangle + E_m^1 |\psi_m^1\rangle + E_m^2 |\psi_m^0\rangle$$

• FIRST-ORDER PERTURBATION THEORY

$$\hookrightarrow H^1 |\psi_m^0\rangle + H^0 |\psi_m^1\rangle = E_m^1 |\psi_m^0\rangle + E_m^0 |\psi_m^1\rangle$$

↳ TAKE INNER PRODUCT WITH  $\langle \psi_m^0 |$

$$\begin{aligned} &\langle \psi_m^0 | H^1 | \psi_m^0 \rangle + \langle \psi_m^0 | H^0 | \psi_m^1 \rangle \\ &= E_m^1 \langle \psi_m^0 | \psi_m^0 \rangle + E_m^0 \langle \psi_m^0 | \psi_m^1 \rangle \end{aligned}$$

$$\hookrightarrow \langle \psi_m^0 | H^0 = \langle \psi_m^0 | E_m^0$$

$$\langle \psi_m^0 | \psi_m^0 \rangle = 1$$



$$\langle \psi_m^0 | H' | \psi_m^0 \rangle + E_m^0 \langle \psi_m^0 | \psi_m^1 \rangle$$

$$= E_m^1 + E_m^0 \langle \psi_m^0 | \psi_m^1 \rangle$$

⇓

$$E_m^1 = \langle \psi_m^0 | H' | \psi_m^0 \rangle$$

NOTE: WE USE THIS WHEN CALCULATING THE CORRECTION DUE TO COULOMB REPULSION BETWEEN 2e<sup>-</sup> IN He ATOM:

$$H' = \frac{e^2}{4\pi\epsilon_0 |\vec{r}_1 - \vec{r}_2|}$$

↳  $|\psi_m^1\rangle$  (FIRST ORDER CORRECTION TO WAVE FUNCTION)

$$(H^0 - E_m^0) |\psi_m^1\rangle = (E_m^1 - H') |\psi_m^0\rangle$$

$|\psi_m^0\rangle$  FORMS COMPLETE SET

$$|\psi_m^1\rangle = \sum_{m \neq n} c_m^{(n)} |\psi_m^0\rangle$$

NOTE: TERM  $|\psi_m^0\rangle$  DOES NOT CONTRIBUTE AS  $(H^0 - E_m^0) |\psi_m^0\rangle = 0$

NOTE

$C_m^{(n)} = 0$

$C_m^{(n)} \equiv \langle \Psi_m^0 | \Psi_m^1 \rangle$

NORMALIZATION  $\langle \Psi_m^0 | \Psi_m^0 \rangle = 1$

$\langle \Psi_m | \Psi_m \rangle = 1$

WITH  $|\Psi_m\rangle = |\Psi_m^0\rangle + \lambda |\Psi_m^1\rangle$   
TO ORDER  $\lambda$

$\langle \Psi_m^0 | \Psi_m^1 \rangle + \langle \Psi_m^1 | \Psi_m^0 \rangle = 0$

$\text{Re } C_m^{(n)} = 0$

WE CAN MAKE A CHANGE OF PHASE

$|\Psi_m\rangle \rightarrow e^{i\lambda\alpha} |\Psi_m\rangle$

AND CHOOSE  $\alpha$  SUCH THAT  $\text{Im } C_m^{(n)} = 0$

$C_m^{(n)} = 0$

$$\sum_{m \neq n} (H^0 - E_m^0) c_m^{(n)} |\psi_m^0\rangle = (E_n^1 - H^1) |\psi_n^0\rangle$$

↓  $|\psi_m^0\rangle$  ARE EIGENSTATES OF  $H^0$

$$\sum_{m \neq n} c_m^{(n)} (E_m^0 - E_n^0) |\psi_m^0\rangle = (E_n^1 - H^1) |\psi_n^0\rangle$$

↓  $\langle \psi_l^0 |$

$$\sum_{m \neq n} c_m^{(n)} (E_m^0 - E_n^0) \langle \psi_l^0 | \psi_m^0 \rangle$$

$$= E_n^1 \langle \psi_l^0 | \psi_n^0 \rangle - \langle \psi_l^0 | H^1 | \psi_n^0 \rangle$$

CASE  $l = n$        $\langle \psi_l^0 | \psi_m^0 \rangle = 0$

→  $E_n^1 = \langle \psi_n^0 | H^1 | \psi_n^0 \rangle$

OK! WE DERIVED THIS BEFORE

CASE  $l \neq n$        $\langle \psi_l^0 | \psi_m^0 \rangle = \delta_{lm}$

$$c_e^{(n)} (E_e^0 - E_n^0) = - \langle \psi_e^0 | H' | \psi_n^0 \rangle$$

$$c_e^{(n)} = \frac{\langle \psi_e^0 | H' | \psi_n^0 \rangle}{E_n^0 - E_e^0}$$

$$\therefore |\psi_n^1\rangle = \sum_{m \neq n} \frac{\langle \psi_m^0 | H' | \psi_n^0 \rangle}{E_n^0 - E_m^0} |\psi_m^0\rangle$$

ONLY APPLIES WHEN UNPERTURBED SPECTRUM IS NON DEGENERATE (i.e. NO 2 ENERGIES  $E_m^0$  ARE SAME)

• SECOND ORDER PERTURBATION THEORY

$$H |\psi_m^1\rangle + H^0 |\psi_m^2\rangle = E_m^0 |\psi_m^2\rangle + E_m^1 |\psi_m^1\rangle + E_m^2 |\psi_m^0\rangle$$

$$\downarrow \langle \psi_m^0 |$$

$$\langle \psi_m^0 | H' | \psi_m^1 \rangle + \langle \psi_m^0 | H^0 | \psi_m^2 \rangle$$

$$= E_m^0 \langle \psi_m^0 | \psi_m^2 \rangle + E_m^1 \langle \psi_m^0 | \psi_m^1 \rangle + E_m^2$$

$$\downarrow \langle \psi_m^0 | H^0 = \langle \psi_m^0 | E_m^0$$



6.7

$$E_m^{(2)} = \langle \psi_m^0 | H' | \psi_m^1 \rangle - E_m^1 \langle \psi_m^0 | \psi_m^1 \rangle$$

$$= \sum_{m \neq n} \frac{\langle \psi_m^0 | H' | \psi_n^0 \rangle}{E_m^0 - E_n^0} \langle \psi_n^0 | H' | \psi_m^0 \rangle$$

$$E_m^{(2)} = \sum_{m \neq n} \frac{|\langle \psi_m^0 | H' | \psi_n^0 \rangle|^2}{E_m^0 - E_n^0}$$

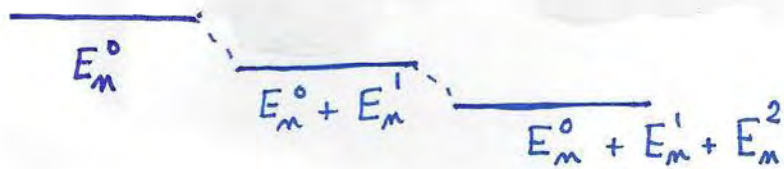
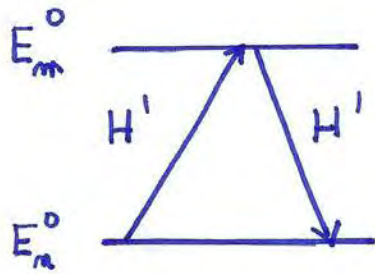



# ⇒ DEGENERATE PERTURBATION THEORY

- if in  $E_m^2 = \sum_{m \neq n} \frac{|\langle \psi_m^0 | H' | \psi_m^0 \rangle|^2}{E_m^0 - E_n^0}$

↓  
 2 ENERGIES  $E_m^0 = E_n^0$  (FOR  $m \neq n$ )

↓  
 $E_m^2$  BLOWS UP → DERIVATION DOES NOT APPLY

- 2 - FOLD DEGENERACY

↳  $E_a^0 = E_b^0 = E^0$

$H^0 |\psi_a^0\rangle = E^0 |\psi_a^0\rangle$

$H^0 |\psi_b^0\rangle = E^0 |\psi_b^0\rangle$

ANY LIN. COMB.  
 $\alpha |\psi_a^0\rangle + \beta |\psi_b^0\rangle$   
 STILL SOLUTION OF  $H^0$

$\langle \psi_a^0 | \psi_b^0 \rangle = 0$

↳ DUE TO PERTURBATION  $H'$

↓  
 DEGENERACY BETWEEN 2 LEVELS IS LIFTED

ASSUME  $|\psi\rangle$  IS SOLUTION OF  $H = H^0 + \lambda H'$   
 ( $\lambda = 1$  AT END)

$E = E^0 + \lambda E^1 + \lambda^2 E^2 + \dots$

$|\psi\rangle = |\psi^0\rangle + \lambda |\psi^1\rangle + \lambda^2 |\psi^2\rangle + \dots$

WITH  $|\psi^0\rangle = \alpha |\psi_a^0\rangle + \beta |\psi_b^0\rangle$

$$H |\Psi\rangle = E |\Psi\rangle$$

$$(H^0 + \lambda H') (|\Psi^0\rangle + \lambda |\Psi^1\rangle + \dots) = (E^0 + \lambda E^1 + \dots) (|\Psi^0\rangle + \lambda |\Psi^1\rangle + \dots)$$

⇓

0-ORDER :  $H^0 |\Psi^0\rangle = E^0 |\Psi^0\rangle$  ORIGINAL PROBLEM SOLVED!

$$1\text{-ORDER} : H^0 |\Psi^1\rangle + H' |\Psi^0\rangle = E^0 |\Psi^1\rangle + E^1 |\Psi^0\rangle$$

TAKE  $\langle \Psi_a^0 |$  & USE  $|\Psi^0\rangle = \alpha |\Psi_a^0\rangle + \beta |\Psi_b^0\rangle$

$$\langle \Psi_a^0 | H^0 |\Psi^1\rangle + \langle \Psi_a^0 | H' |\Psi^0\rangle = E^0 \langle \Psi_a^0 | \Psi^1\rangle + \alpha E^1$$

$$\langle \Psi_a^0 | H^0 |\Psi^1\rangle = E^0 \langle \Psi_a^0 | \Psi^1\rangle$$

$$\alpha \langle \Psi_a^0 | H' | \Psi_a^0 \rangle + \beta \langle \Psi_a^0 | H' | \Psi_b^0 \rangle = \alpha E^1$$

NOTE : IF  $\beta = 0$  WE FIND BACK FIRST ORDER FORMULA IN NON-DEGENERATE CASE  
 $\alpha = 1$

↳ INTRODUCE 'TRANSITION MATRIX ELEMENTS'

$$W_{ij} \equiv \langle \psi_i^0 | H' | \psi_j^0 \rangle$$

KNOWN ONCE WE SOLVED FOR  $|\psi_i^0\rangle$

1-ORDER FORMULA  $\underline{\alpha E^1 = \alpha W_{aa} + \beta W_{ab}} \quad (*)$

IF TAKING CONTRACTION WITH  $\langle \psi_b^0 |$  INSTEAD,  
WE FIND AN ANALOGOUS FORMULA ( $a \leftrightarrow b$ )

$$\underline{\beta E^1 = \beta W_{bb} + \alpha W_{ba}} \quad (**)$$

$(**) \cdot W_{ab}$

$$(\beta W_{ab}) E^1 = (\beta W_{ab}) W_{bb} + \alpha |W_{ab}|^2$$

↓ USE (\*) FOR  $\beta W_{ab}$

$$(\alpha E^1 - \alpha W_{aa}) (E^1 - W_{bb}) = \alpha |W_{ab}|^2$$

↓  $\alpha$  DROPS OUT

$$E^{1^2} - (W_{aa} + W_{bb}) E^1 + W_{aa} W_{bb} - |W_{ab}|^2 = 0$$

$$E_{\pm}^1 = \frac{1}{2} \left[ W_{aa} + W_{bb} \pm \sqrt{(W_{aa} - W_{bb})^2 + 4|W_{ab}|^2} \right]$$

SPECIAL CASES

$$|\Psi^0\rangle = \alpha |\Psi_a^0\rangle + \beta |\Psi_b^0\rangle$$

$$\leadsto \alpha = 1, \beta = 0 \Rightarrow W_{ba} = 0 \quad (**)$$

$$E^1 = W_{aa} \stackrel{!}{=} E_+^1 \quad (*)$$

$$\leadsto \alpha = 0, \beta = 1 \Rightarrow W_{ab} = 0 \quad (*)$$

$$E^1 = W_{bb} \stackrel{!}{=} E_-^1 \quad (**)$$

IN BOTH CASES WE FIND BACK RESULTS OF NON-DEGENERATE PERTURBATION THEORY

IN GENERAL

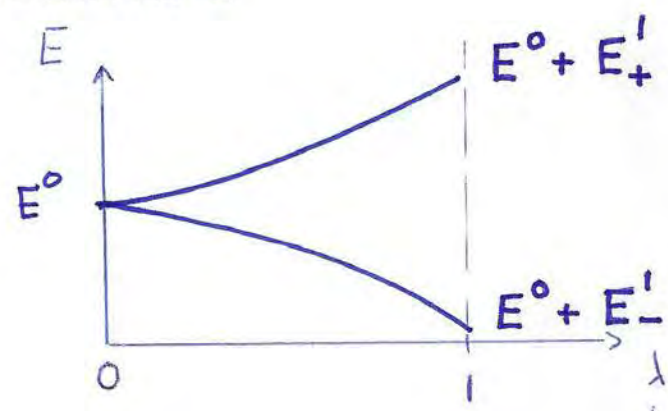

↳ DENOTES 'SWITCHING ON' THE PERTURBATION H^1 FROM 0 TO 1



↳ USEFUL THEOREM TO DETERMINE 'GOOD' LINEAR COMBINATION TO APPLY NON-DEG. P.T.

THEOREM: A HERMITIAN OPERATOR

$$[A, H^0] = [A, H'] = 0$$

IF  $|\psi_a^0\rangle$  AND  $|\psi_b^0\rangle$  ARE ALSO EIGENFUNCTIONS

OF A:

$$A|\psi_a^0\rangle = \mu|\psi_a^0\rangle$$

$$A|\psi_b^0\rangle = \nu|\psi_b^0\rangle$$

SUCH THAT  $\mu \neq \nu$



$W_{ab} = 0 \Rightarrow$  WE CAN APPLY NON-DEG. PT

$$E_+ = W_{aa} = \langle \psi_a^0 | H' | \psi_a^0 \rangle$$

$$E_- = W_{bb} = \langle \psi_b^0 | H' | \psi_b^0 \rangle$$

PROOF:  $0 = \langle \psi_a^0 | [A, H'] | \psi_b^0 \rangle$

$$= \langle \psi_a^0 | AH' | \psi_b^0 \rangle - \langle \psi_a^0 | H'A | \psi_b^0 \rangle$$

$$= (\mu - \nu) \langle \psi_a^0 | H' | \psi_b^0 \rangle$$

$$= (\mu - \nu) W_{ab} \Rightarrow \text{IF } \mu \neq \nu \Rightarrow W_{ab} = 0 \blacksquare$$

• MATRIX NOTATION

2- FOLD DEGENERACY

↳  $H^0 |N_a^0\rangle = E^0 |N_a^0\rangle$

$H^0 |N_b^0\rangle = E^0 |N_b^0\rangle$

$|N^0\rangle = \alpha |N_a^0\rangle + \beta |N_b^0\rangle$

↳  $H = H^0 + \lambda H^1$

$E = E^0 + \lambda E^1 + \dots$

$|N\rangle = |N^0\rangle + \lambda |N^1\rangle + \dots$

$H|N\rangle = E|N\rangle$

TO FIRST ORDER IN PERTURBATION

2 EQS. 
$$\begin{cases} \alpha W_{aa} + \beta W_{ab} = \alpha E^1 \\ \alpha W_{ba} + \beta W_{bb} = \beta E^1 \end{cases}$$

↳ IN MATRIX NOTATION: WITH  $W_{ij} \equiv \langle N_i^0 | H^1 | N_j^0 \rangle$

$$\underbrace{\begin{pmatrix} W_{aa} & W_{ab} \\ W_{ba} & W_{bb} \end{pmatrix}}_{\equiv W} \begin{pmatrix} \alpha \\ \beta \end{pmatrix} = E^1 \begin{pmatrix} \alpha \\ \beta \end{pmatrix}$$

∴  $E^1$  : EIGENVALUES OF  $W$  MATRIX

$(\alpha, \beta)$  : GOOD LIN. COMB. OF UNPERTURBED STATES

↳ EIGENVECTORS OF  $W$

## • HIGHER-ORDER DEGENERACY

↳  $m$ -FOLD DEGENERACY

$$|N_1^0\rangle, |N_2^0\rangle, \dots, |N_m^0\rangle$$

ARE DEGENERATE  $\rightarrow$  ENERGY  $E^0$

↳  $m \times m$  - MATRIX  $W$

$$W_{ij} \equiv \langle N_i^0 | H' | N_j^0 \rangle$$

↳ FIRST ORDER CORRECTIONS TO ENERGY  $\Rightarrow$  EIGENVALUES OF  $W$

GOOD LIN. COMB. OF UNPERTURBED STATES



EIGENVECTORS OF  $W$

• EXAMPLE : 3-DIM INFINITE CUBIC WELL WITH PERTURBATION

$$\hookrightarrow H^0 = \frac{\hat{p}^2}{2m} + V(x, y, z)$$

$$V(x, y, z) = \begin{cases} 0 & , \quad 0 < x < a \\ & , \quad 0 < y < a \\ & , \quad 0 < z < a \\ \infty & , \quad \text{OTHERWISE} \end{cases}$$

$$\hookrightarrow H^1 = \begin{cases} V_0 & , \quad 0 < x < a/2 \\ & , \quad 0 < y < a/2 \\ 0 & , \quad \text{OTHERWISE} \end{cases}$$

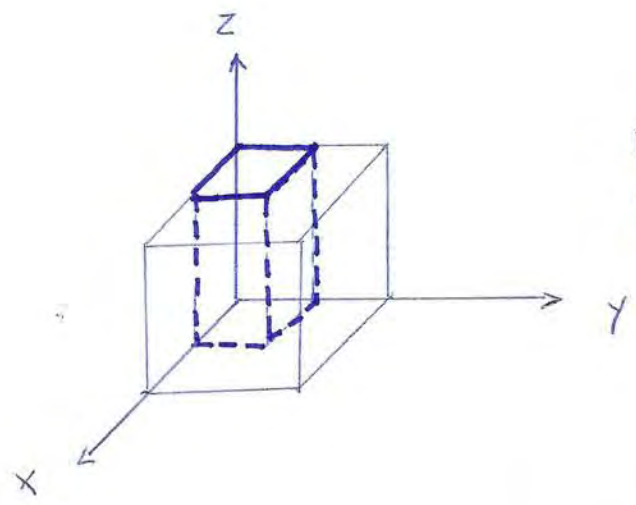

PARTICLE FEELS PERTURBATION WHEN IT IS IN SMALLER BOX



↳ UNPERTURBED PROBLEM

$$\Psi_{m_x m_y m_z}^0(x, y, z) = C \sin\left(m_x \frac{\pi}{a} x\right) \sin\left(m_y \frac{\pi}{a} y\right) \sin\left(m_z \frac{\pi}{a} z\right)$$

$$C = \left(\frac{2}{a}\right)^{3/2}$$

$$E_{m_x m_y m_z}^0 = \frac{\hbar^2}{2m} \frac{\pi^2}{a^2} (m_x^2 + m_y^2 + m_z^2)$$

↳ GROUND STATE :  $m_x = m_y = m_z = 1$

NON-DEGENERATE  $E_0^0 = \frac{\hbar^2}{2m} \frac{3\pi^2}{a^2}$

↳ FIRST EXCITED STATE :  $m_x = 1, m_y = 1, m_z = 2$

$$m_x = 1, m_y = 2, m_z = 1$$

$$m_x = 2, m_y = 1, m_z = 1$$

TRIPLY DEGENERATE

$$\Psi_a^0 \equiv \Psi_{112}^0, \quad \Psi_b^0 \equiv \Psi_{121}^0, \quad \Psi_c^0 \equiv \Psi_{211}^0$$

ALL 3 HAVE SAME ENERGY

$$E_1^0 = \frac{\hbar^2}{2m} \frac{6\pi^2}{a^2}$$

↳ PERTURBATION THEORY

$$|N^0\rangle \equiv \alpha |N_a^0\rangle + \beta |N_b^0\rangle + \gamma |N_c^0\rangle$$

↳ GOOD LIN. COMB OF UNPERTURBED STATES

$$W_{ij} = \langle N_i^0 | H' | N_j^0 \rangle$$

$i, j = a, b, c$

- $$W_{aa} = W_{bb} = W_{cc}$$

$$= \left(\frac{2}{a}\right)^3 V_0 \int_0^{a/2} dx \sin^2\left(\frac{\pi}{a}x\right) \int_0^{a/2} dy \sin^2\left(\frac{\pi}{a}y\right) \int_0^a dz \sin^2\left(\frac{2\pi}{a}z\right)$$

$$= \left(\frac{2}{a}\right)^3 V_0 \cdot \left(\frac{1}{2} \frac{a}{2}\right) \left(\frac{1}{2} \frac{a}{2}\right) \left(\frac{1}{2} a\right)$$

$$= \frac{V_0}{4}$$

$$\begin{aligned}
 \bullet \quad W_{ab} &= \left(\frac{2}{a}\right)^3 V_0 \int_0^{a/2} dx \sin^2\left(\frac{\pi}{a}x\right) \\
 &\quad \cdot \int_0^{a/2} dy \sin\left(\frac{\pi}{a}y\right) \sin\left(\frac{2\pi}{a}y\right) \\
 &\quad \cdot \int_0^a dz \underbrace{\sin\left(\frac{2\pi}{a}z\right) \sin\left(\frac{\pi}{a}z\right)} \\
 &\quad \quad \quad \frac{1}{2} \left( \cos\frac{\pi}{a}z - \cos\frac{3\pi}{a}z \right) \\
 &\quad \quad \quad \downarrow \int_0^a \quad \downarrow \\
 &\quad \quad \quad 0 \quad \quad 0
 \end{aligned}$$

$$W_{ab} = W_{ac} = 0$$

$$\begin{aligned}
 \bullet \quad W_{bc} &= \left(\frac{2}{a}\right)^3 V_0 \int_0^{a/2} dx \sin\left(\frac{\pi}{a}x\right) \sin\left(\frac{2\pi}{a}x\right) \\
 &\quad \cdot \int_0^{a/2} dy \sin\left(\frac{2\pi}{a}y\right) \sin\left(\frac{\pi}{a}y\right) \\
 &\quad \cdot \int_0^a dz \sin^2\left(\frac{\pi}{a}z\right) \\
 &= \left(\frac{2}{a}\right)^3 \cdot V_0 \cdot \left(\frac{1}{2} \cdot \frac{4}{3} \frac{a}{\pi}\right) \left(\frac{1}{2} \cdot \frac{4}{3} \frac{a}{\pi}\right) \cdot \left(\frac{1}{2} a\right) \\
 &= \frac{16}{9} \frac{1}{\pi^2} V_0
 \end{aligned}$$

$$W = \frac{V_0}{4} \begin{pmatrix} 1 & 0 & 0 \\ 0 & 1 & K \\ 0 & K & 1 \end{pmatrix}$$

$$K \equiv \left( \frac{8}{3\pi} \right)^2$$

$$\begin{vmatrix} 1-\omega & 0 & 0 \\ 0 & 1-\omega & K \\ 0 & K & 1-\omega \end{vmatrix} = 0$$



$$(1-\omega)^3 - K^2(1-\omega) = 0$$

$$\left\{ \begin{array}{ll} \omega_1 = 1 & \Rightarrow E_1^{(1)} = E_1^0 + \frac{V_0}{4} \\ \omega_2 = 1 + K & \Rightarrow E_1^{(2)} = E_1^0 + \frac{V_0}{4} (1 + K) \\ \omega_3 = 1 - K & \Rightarrow E_1^{(3)} = E_1^0 + \frac{V_0}{4} (1 - K) \end{array} \right.$$

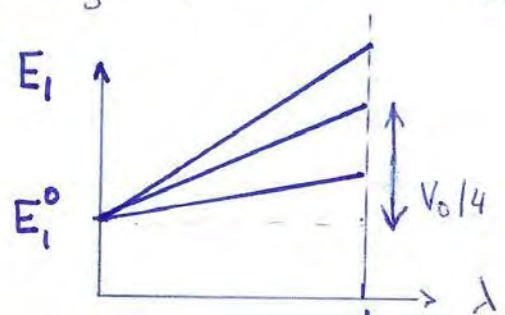

↑  
UNPERTURBED  
ENERGIES



• GOOD UNPERTURBED STATES

$$\begin{pmatrix} 1 & 0 & 0 \\ 0 & 1 & K \\ 0 & K & 1 \end{pmatrix} \begin{pmatrix} \alpha \\ \beta \\ \gamma \end{pmatrix} = \omega \begin{pmatrix} \alpha \\ \beta \\ \gamma \end{pmatrix}$$

$$\rightsquigarrow \omega = 1 \quad \Leftrightarrow \quad \beta = \gamma = 0, \quad \alpha = 1$$

$$\rightsquigarrow \omega = 1 + K \quad \Leftrightarrow \quad \alpha = 0, \quad \beta = \gamma = \frac{1}{\sqrt{2}}$$

$$\rightsquigarrow \omega = 1 - K \quad \Leftrightarrow \quad \alpha = 0, \quad \beta = -\gamma = \frac{1}{\sqrt{2}}$$

$$|N^0\rangle = \begin{cases} |N_a^0\rangle \\ \frac{1}{\sqrt{2}} \{ |N_b^0\rangle + |N_c^0\rangle \} \\ \frac{1}{\sqrt{2}} \{ |N_b^0\rangle - |N_c^0\rangle \} \end{cases}$$



CORRESPOND WITH 3 STATES.

FIRST - ORDER CORRECTION TO STATES

$E_m^0$   }  $d_m$  FOLD DEGENERATE

$E_m^0$   }  $d_m$  FOLD DEGENERATE  $\Rightarrow$  STATES  $|\Psi_{m,1}^0\rangle,$   
 $|\Psi_{m,2}^0\rangle,$   
 $\dots$   
 $|\Psi_{m,d_m}^0\rangle$

GOOD UNPERTURBED STATES

$$|\Psi_{m,i}^0\rangle = \sum_{j=1}^{d_m} \alpha_{ij} |\Psi_{m,j}^0\rangle$$

$\hookrightarrow i = 1 \dots d_m$

\* FIRST ORDER EQ. FOR STATE  $m_i$  ( $i = 1 \dots d_m$ )

$$H^0 |\Psi_{m,i}^1\rangle + H^1 |\Psi_{m,i}^0\rangle = E_m^0 |\Psi_{m,i}^1\rangle + E_{m_i}^1 |\Psi_{m,i}^0\rangle$$

$\downarrow$

$|\Psi_{m,i}^1\rangle$  CAN BE EXPANDED IN COMPLETE BASIS

$$(H^0 - E_m^0) |\Psi_{m,i}^1\rangle = (E_{m_i}^1 - H^1) |\Psi_{m,i}^0\rangle$$

$$|N_{m_i}^1\rangle = \sum_{m \neq n} \sum_{j=1}^{d_m} c_{m_i, m_j} |N_{m_j}^0\rangle$$

---

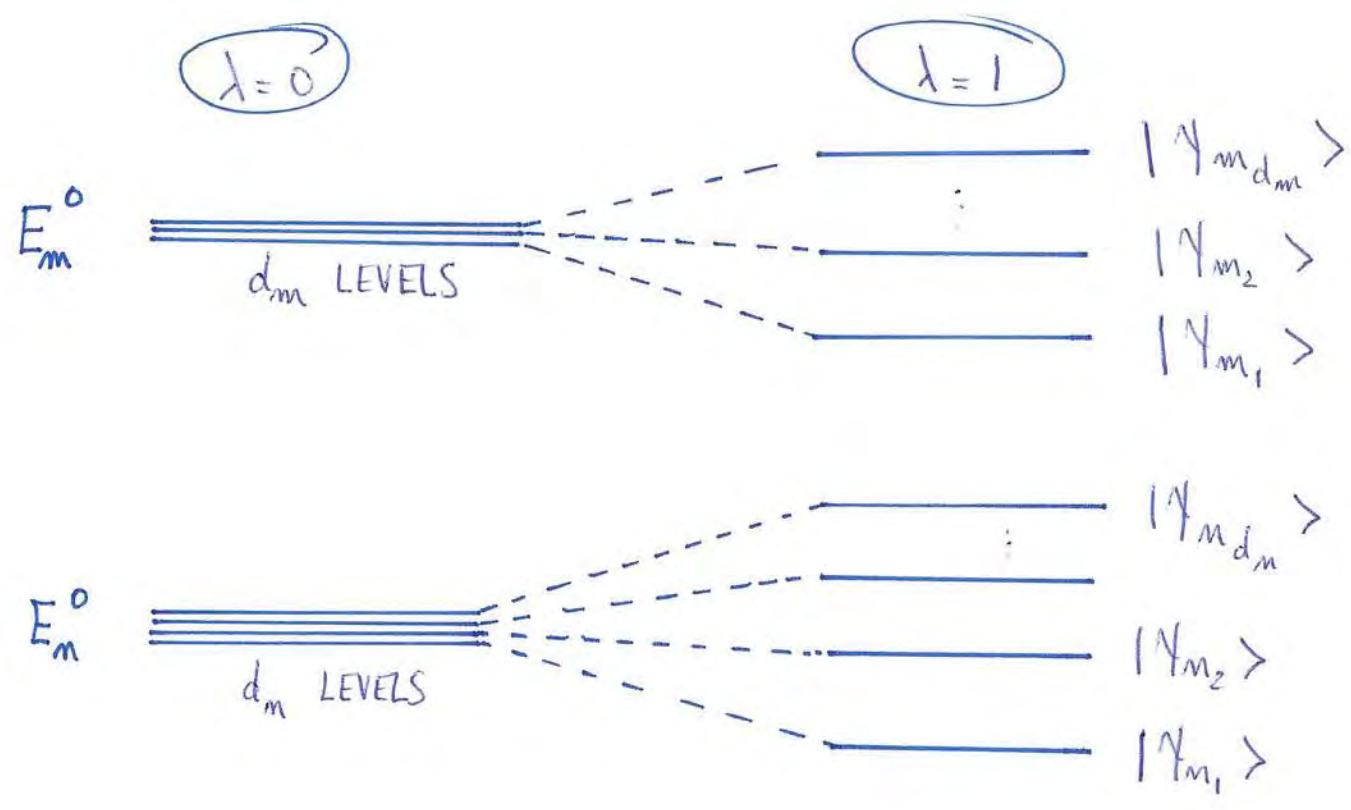

$$(H^0 - E_m^0) \sum_{m \neq n} \sum_{j=1}^{d_m} c_{m_i, m_j} |N_{m_j}^0\rangle$$

$$= (E_{m_i}^1 - H^1) |N_{m_i}^0\rangle$$

$$\begin{aligned} & \Downarrow \\ \sum_{m \neq n} (E_m^0 - E_n^0) \sum_{j=1}^{d_m} c_{n_i, m_j} |\Psi_{m_j}^0\rangle \\ & = (E_{n_i}^0 - H') |\Psi_{n_i}^0\rangle \end{aligned}$$

$$\begin{aligned} & \Downarrow \\ & \langle \Psi_{m_k}^0 | \quad m \neq n \\ & (E_m^0 - E_n^0) \sum_{j=1}^{d_m} c_{n_i, m_j} \underbrace{\langle \Psi_{m_k}^0 | \Psi_{m_j}^0 \rangle}_{\delta_{jk}} \\ & = \langle \Psi_{m_k}^0 | (\cancel{E_{n_i}^0} - H') |\Psi_{n_i}^0\rangle \\ & \quad m \neq n \end{aligned}$$

$$(E_m^0 - E_n^0) c_{n_i, m_k} = - \langle \Psi_{m_k}^0 | H' | \Psi_{n_i}^0 \rangle$$

$$|\Psi_{n_i}^1\rangle = \sum_{m \neq n} \sum_{j=1}^{d_m} \frac{\langle \Psi_{m_j}^0 | H' | \Psi_{n_i}^0 \rangle}{E_m^0 - E_n^0} \cdot |\Psi_{m_j}^0\rangle$$



## ⇒ FINE STRUCTURE OF HYDROGEN

● BOHR THEORY FOR H:  $E_n = \frac{E_1}{n^2}$

$$E_1 = - \frac{m}{2\hbar^2} \left( \frac{e^2}{4\pi\epsilon_0} \right)^2 = - 13.6 \text{ eV}$$

↓

$$\alpha \equiv \frac{e^2}{4\pi\epsilon_0 \hbar c} \approx \frac{1}{137}$$

↳ FINE STRUCTURE CONSTANT  
DIMENSIONLESS PARAMETER  
WHICH DENOTES STRENGTH OF  
ELECTROMAGNETIC INTERACTION

$$E_1 = - \frac{\alpha^2}{2} m c^2$$

● FINE-STRUCTURE CORRECTIONS TO  $E_n$

- 1) RELATIVISTIC CORRECTIONS
- 2) SPIN-ORBIT COUPLING

SPIN  $\frac{1}{2}$  IS COUPLED WITH ORBITAL ANGULAR  
MOMENTUM  $\vec{l}$  TO TOTAL ANGULAR MOMENTUM  $\vec{j}$

## RELATIVISTIC CORRECTIONS

↳ NON REL.  $p = m v$

KIN. EN. :  $T = \frac{1}{2} m v^2 = \frac{p^2}{2m}$

↳ REL.  $p = m_{rel} v$

$$m_{rel} = \frac{m}{\sqrt{1 - v^2/c^2}}$$

RELATIVISTIC  
MASS

REST MASS :  
MASS IN FRAME  
WHERE  $v = 0$ .

TOTAL ENERGY (OF FREE PARTICLE)  $E = m_{rel} c^2$  (EINSTEIN FORMULA)

$$= \frac{m}{\sqrt{1 - v^2/c^2}} c^2$$

KINETIC ENERGY OF PARTICLE MOVING WITH VELOCITY  $v$

$$T = E - \underbrace{m c^2}_{\text{REST ENERGY}}$$

(WHEN PARTICLE IS AT REST  $v = 0 \Rightarrow T = 0$ )

$$\begin{aligned}
 T &= m_{\text{rel}} c^2 - m c^2 \\
 &= \frac{m}{\sqrt{1 - v^2/c^2}} c^2 - m c^2
 \end{aligned}$$

$$\hookrightarrow E^2 = \frac{m^2 c^4}{1 - v^2/c^2}$$

$$= \frac{1}{1 - v^2/c^2} \left\{ 1 - \frac{v^2}{c^2} + \frac{v^2}{c^2} \right\} m^2 c^4$$

$$= \frac{v^2/c^2}{1 - v^2/c^2} \cdot m^2 c^4 + m^2 c^4$$

$$= \frac{m^2}{1 - v^2/c^2} v^2 c^2 + m^2 c^4$$

$$\boxed{E^2 = c^2 p^2 + m^2 c^4} \Rightarrow E = \sqrt{c^2 p^2 + m^2 c^4}$$

$$\hookrightarrow T = E - m c^2$$

$$= \sqrt{c^2 p^2 + m^2 c^4} - m c^2$$

FOR A NONREL. SYSTEM

$$\frac{v \ll c}{\Downarrow} \quad (e^- \text{ MOVES WITH VELOCITY MUCH SMALLER THAN VELOCITY OF LIGHT})$$

$$p \ll mc$$

(FOR H OK !

$$\langle T \rangle \approx 10 \text{ eV}$$

$$mc^2 \approx 511 \text{ keV}$$

$$\frac{\langle T \rangle}{mc^2} \approx \underline{\underline{0.2 \cdot 10^{-4}}}$$

EXPAND RELATIVISTIC KINETIC ENERGY

$$T = \sqrt{m^2 c^4 + c^2 p^2} - mc^2$$

$$= mc^2 \sqrt{1 + \frac{p^2}{m^2 c^2}} - mc^2$$

$$= mc^2 \left( 1 + \frac{p^2}{2m^2 c^2} - \frac{1}{8} \left( \frac{p^2}{m^2 c^2} \right)^2 + O(p^6) \right)$$

$$- mc^2$$

$$T = \frac{p^2}{2m} - \frac{p^4}{8m^3 c^2} + \dots$$

NONREL. KIN. EN

RELATIVISTIC CORRECTION



↳ CONSIDER RELATIVISTIC CORRECTION  
AS PERTURBATION

$$H^0 = \frac{\hat{P}^2}{2m} - \underbrace{\frac{\alpha \hbar c}{r}}_{\hat{V}}$$

$$H'_{rel} = - \frac{\hat{P}^4}{8m^3 c^2}$$

1<sup>o</sup> ORDER PERTURBATION THEORY

APPLY NON-DEG. PT

$$[L^2, H'] = 0$$

$$[L_z, H'] = 0$$

PERT. IS  
SPHERICAL SYMM.

$$E'_{rel} = \langle \psi^0 | H'_{rel} | \psi^0 \rangle$$

REL. CORRECTION  
TO H-ATOM  
ENERGIES

UNPERTURBED H-ATOM  
WAVE FUNCTIONS

$$E'_{rel} = - \frac{1}{8m^3 c^2} \langle \psi^0 | \hat{P}^4 | \psi^0 \rangle$$

$$= - \frac{1}{8m^3 c^2} \langle \hat{P}^2 \psi^0 | \hat{P}^2 \psi^0 \rangle$$

$$\Downarrow \quad \frac{\hat{P}^2}{2m} \psi^0 = (E - \hat{V}) \psi^0$$

$$E'_{rel} = -\frac{1}{2mc^2} \langle \psi^0 | (E - \hat{V})^2 | \psi^0 \rangle$$

$$= -\frac{1}{2mc^2} \left\{ E^2 - 2E \langle \hat{V} \rangle + \langle \hat{V}^2 \rangle \right\}$$

$$\Downarrow \quad \hat{V} = -\frac{\alpha \hbar c}{r}$$

$$E'_{rel} = -\frac{1}{2mc^2} \left\{ E_m^2 + 2E_m \alpha \hbar c \left\langle \frac{1}{r} \right\rangle + \alpha^2 (\hbar c)^2 \left\langle \frac{1}{r^2} \right\rangle \right\}$$

FOR LEVEL  $m$

↳ EVALUATE  $\left\langle \frac{1}{r} \right\rangle$ ,  $\left\langle \frac{1}{r^2} \right\rangle$

IN STATE  $\psi^0 = \psi_{mlm}$

H-ATOM UNPERTURBED  
WAVE FUNCTIONS.

$$\psi_{100} = \frac{1}{\sqrt{\pi a^3}} e^{-r/a}$$

BOHR RADIUS

$$a = \left( \frac{4\pi\epsilon_0}{e^2} \right) \frac{\hbar^2}{m} = \frac{1}{\alpha m} \frac{\hbar}{c}$$

↳ USE FEYNMAN - HELLMANN THEOREM

TO EVALUATE  $\langle \frac{1}{r} \rangle$ ,  $\langle \frac{1}{r^2} \rangle$  IN GENERAL STATE  $\Psi_{n\ell m}$

FEYNMAN HELLMANN THEOREM !

IF H DEPENDS ON SOME PARAMETER  $\lambda$

↳  $E_m(\lambda)$ ,  $\Psi_m(\lambda)$  EIGENVALUES, EIGENFUNCTIONS OF  $H(\lambda)$

⇓

$$\frac{\partial E_m}{\partial \lambda} = \langle \Psi_m | \frac{\partial H}{\partial \lambda} | \Psi_m \rangle$$

PROOF : WE CAN ASSUME

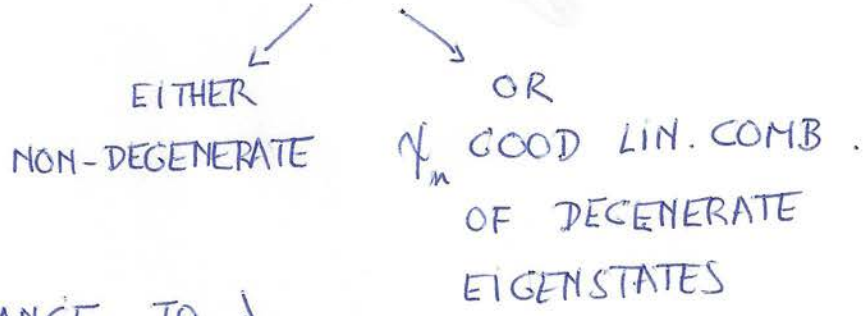

INFINITESIMAL CHANGE TO  $\lambda$

$$\lambda = \lambda_0 + d\lambda \quad H(\lambda) = H(\lambda_0) + d\lambda \left. \frac{\partial H}{\partial \lambda} \right|_{\lambda_0} + O(d\lambda)^2$$

1<sup>o</sup> ORDER CORRECTION TO ENERGY

$$dE_m \approx \langle \Psi_m | \underbrace{H'}_{d\lambda \frac{\partial H}{\partial \lambda}} | \Psi_m \rangle$$

$$\frac{\partial E_m}{\partial \lambda} = \langle \Psi_m | \frac{\partial H}{\partial \lambda} | \Psi_m \rangle$$

↳ RADIAL SCHRÖDINGER EQ. FOR H-ATOM

$$H^0 = -\frac{\hbar^2}{2m} \frac{d^2}{dr^2} + \underbrace{\frac{\hbar^2 l(l+1)}{2m r^2}}_{\text{'CENTRIFUGAL' TERM}} - \frac{\alpha \hbar c}{r}$$

↓

EIGENVALUES  $E_n = -\left(\frac{1}{2} mc^2 \alpha^2\right) \frac{1}{n^2}$

\* APPLY FEYNMAN - HELLMANN THEOREM FOR  $\lambda = \alpha$

$$\frac{\partial H^0}{\partial \alpha} = -\frac{\hbar c}{r}$$

$$\frac{\partial E_n}{\partial \alpha} = -\frac{\alpha mc^2}{n^2}$$

⇓

$$\left\langle \frac{1}{r} \right\rangle = \frac{\alpha mc^2}{\hbar c} \frac{1}{n^2} = \frac{1}{a n^2}$$

$$= -\frac{2E_n}{\alpha \hbar c}$$



\* APPLY FEYNMAN - HELLMANN THEOREM FOR  $\lambda = \ell$

$$\left\langle \frac{\partial H^0}{\partial \ell} \right\rangle = \frac{\hbar^2}{m} \left\langle \frac{1}{r^2} \right\rangle \left( \ell + \frac{1}{2} \right)$$

$$E_m = + \frac{E_1}{(j_{\max} + \ell + 1)^2}$$

$$m = \underset{\substack{\uparrow \\ \text{INTEGER}}}{j_{\max} + \ell + 1}$$

$$\frac{\partial E_m}{\partial \ell} = - \frac{2 E_1}{m^3} = - \frac{2m}{E_1} \cdot E_m^2$$

$$\left\langle \frac{1}{r^2} \right\rangle = - \frac{2 E_1 m}{\hbar^2} \frac{1}{\left( \ell + \frac{1}{2} \right) m^3}$$

$$\downarrow \quad -E_1 = \frac{1}{2} m c^2 \alpha^2$$

$$\left\langle \frac{1}{r^2} \right\rangle = \frac{1}{a^2} \frac{1}{\left( \ell + \frac{1}{2} \right) m^3}$$

$$E_{rel}' = -\frac{1}{2mc^2} \left\{ E_m^2 + 2E_m \alpha \hbar c \frac{1}{an^2} + \alpha^2 \hbar^2 c^2 \frac{1}{a^2 (l + \frac{1}{2}) n^3} \right\}$$

$$\downarrow E_m = -\left(\frac{1}{2} mc^2 \alpha^2\right) \frac{1}{n^2}$$

$$\frac{1}{an^2} = \alpha m \frac{c}{\hbar} \frac{1}{n^2} = -\frac{2E_m}{\hbar c} \frac{1}{\alpha}$$

$$E_{rel}' = -\frac{1}{2mc^2} \left\{ E_m^2 - (2E_m) \cdot (2E_m) + \frac{m}{(l + \frac{1}{2})} 4E_m^2 \right\}$$

$$E_{rel}' = -\frac{E_m^2}{2mc^2} \left\{ -3 + \frac{4m}{l + 1/2} \right\}$$

DEPENDS  
ON  
n AND l!

SIZE:  $\frac{E_m^2}{2mc^2} \approx \frac{(13.6 \text{ eV})^2}{1.022 \times 10^6 \text{ eV}} \approx 1.8 \times 10^{-4} \text{ eV}$

OF ORDER  $\alpha^2 \sim 10^{-4}$   
RELATIVE TO  $E_m$

↳  $m = 1$   
 $l = 0$

$$E'_{rel} = -\frac{E_1^2}{2mc^2} \left\{ -3 + \frac{4}{1/2} \right\}$$

$$= -\frac{E_1^2}{2mc^2} \cdot 5 \approx 10^{-3} \text{ eV}$$

↳  $m = 2$   
 $l = 0$

$$E'_{rel} = -\frac{E_2^2}{2mc^2} \left\{ -3 + \frac{16}{13} \right\}$$

$l = 1$

$$E'_{rel} = -\frac{E_2^2}{2mc^2} \left\{ -3 + \frac{16}{3} \right\}$$

$H^0$

$H^0 + H'_{rel}$

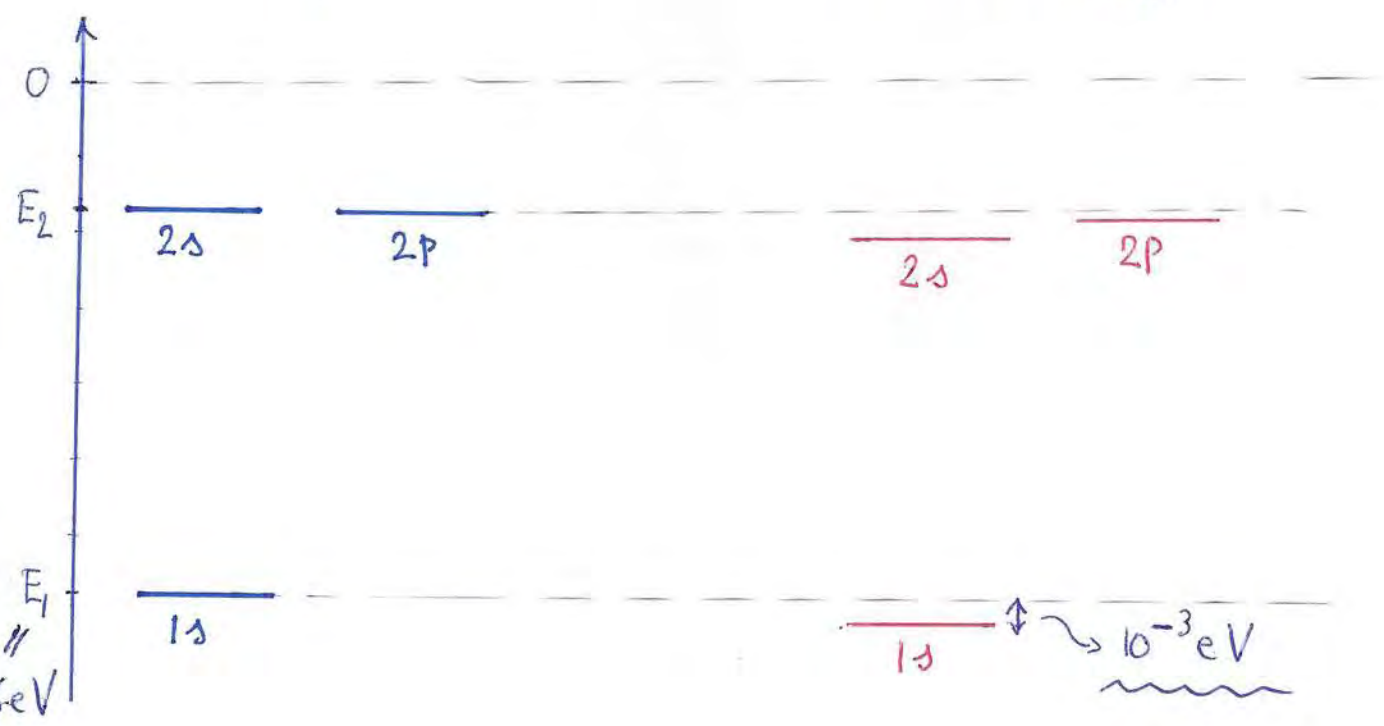

## SPIN-ORBIT COUPLING

↳ in  $e^-$  REFERENCE FRAME



PROTON (CHARGE  $+e$ ) IS CIRCLING AROUND IT



CURRENT LOOP CREATES A MAGN. FIELD  $\vec{B}$   
WHICH INTERACTS WITH MAGN. MOMENT  $\vec{\mu}$  OF  $e^-$

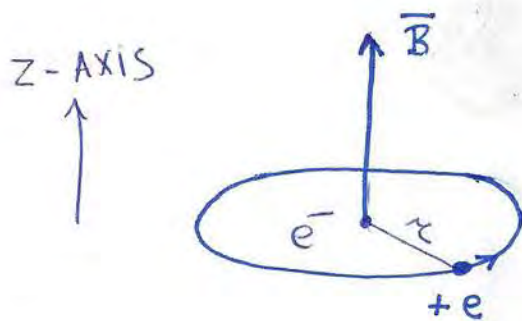

↳  $\vec{B}$  FIELD CREATED BY PROTON

CURRENT 
$$\vec{I} = \frac{e}{T}$$

$T$  = PERIOD OF ORBIT

$$\nu = \frac{2\pi r}{T}$$

$\vec{B}$  - FIELD AT CENTER OF LOOP

$$\vec{B} = \frac{\mu_0 \vec{I}}{2r} \vec{e}_z \quad (\text{BIOT-SAVART}) \quad \epsilon_0 \mu_0 = \frac{1}{c^2}$$

$e^-$  ORBITAL ANGULAR MOM. IN REST FRAME OF P

$$\vec{L} = m \nu r \vec{e}_z = \frac{2\pi m r^2}{T} \vec{e}_z$$



$$\vec{B} = \frac{\mu_0 e}{2\pi r} \vec{e}_z$$

$$= \frac{\mu_0 e}{4\pi r^3 m} \left( \frac{2\pi m r^2}{T} \right) \vec{e}_z$$

$\underbrace{\hspace{10em}}_{\vec{L}}$

$$\vec{B} = \frac{e}{4\pi \epsilon_0 c^2} \frac{1}{m r^3} \vec{L}$$

↳  $\vec{\mu}$  of  $e^-$

$$\vec{\mu} = \gamma \vec{S}$$

CLASSICAL  $\gamma = \frac{q}{2m} = - \frac{e}{2m}$

↑  
FOR  $e^-$

QUANTUM  $\gamma = g \frac{q}{2m}$

↑  
g-FACTOR

DIRAC THEORY (RELATIVISTIC QM)

EXPLAINS  $g = 2$  ✓ FOR SPIN 1/2 POINT PARTICLE

$$\therefore \boxed{\vec{\mu}_e = - \frac{ze}{em} \vec{S} = - \frac{e}{m} \vec{S}}$$

↳ SPIN-ORBIT INTERACTION

$$\begin{aligned} H'_{so} &= - \vec{\mu}_e \cdot \vec{B} \\ &= + \frac{e}{m} \frac{e}{4\pi\epsilon_0 c^2} \frac{1}{m\hbar^3} \vec{L} \cdot \vec{S} \end{aligned}$$

$$\boxed{H'_{so} = \frac{1}{2} \alpha \frac{\hbar}{c} \frac{1}{m^2 \hbar^3} \vec{L} \cdot \vec{S}}$$

IF ONE DOES THE CORRECT RELATIVISTIC CALCULATION

(THOMAS PRECESSION:

BECAUSE  $e^-$  REST FRAME IS NOT INERTIAL

↓

ACCELERATES AS  $e^-$  ORBITS p

INTERACTION DEPENDS ON VALUE OF

TOTAL ANGULAR MOMENTUM  $\vec{J} = \vec{L} + \vec{S}$

$$\vec{L} \cdot \vec{S} = \frac{1}{2} (J^2 - L^2 - S^2)$$

EIGENVALUES

$$\rightarrow \frac{\hbar^2}{2} (j(j+1) - l(l+1) - \frac{3}{4})$$

GOOD EIGENSTATES ARE

EIGENSTATES OF  $J^2, J_z, L^2, S^2$ .

(  $L_z, S_z$  DO NOT COMMUTE WITH  $H'_{so}$  )

o o "GOOD" UNPERTURBED STATES  $|N^0\rangle = |N_{n j m_j l s}\rangle$

5 QUANTUM NUMBERS:  
 $n, j, m_j, l, s$

↳ CORRECTION TO ENERGY DUE TO S.O.

$$E'_{so} = \langle N_{n j m_j l s} | H'_{so} | N_{n j m_j l s} \rangle$$

$$= \frac{1}{2} \alpha \frac{\hbar}{c} \frac{1}{m^2} \frac{\hbar^2}{2} \left[ j(j+1) - l(l+1) - \frac{3}{4} \right]$$

$$\cdot \left\langle \frac{1}{r^3} \right\rangle$$

PROBLEM 6.35 c) USING  $\left\langle \frac{1}{r^2} \right\rangle$

$$\left\langle \frac{1}{r^3} \right\rangle = \frac{1}{l(l + \frac{1}{2})(l+1)} \frac{1}{n^3 a^3}$$

$$\frac{1}{n^3 a^3} = \frac{m}{a} \left( \frac{1}{n^2 a} \right)^2$$

$$= \frac{m}{a} \frac{4 E_m^2}{\hbar^2 c^2} \frac{1}{\alpha^2}$$

$$\frac{1}{a} = \alpha m \frac{c}{\hbar}$$

$$= m \frac{4 E_m^2 m}{\hbar^3 c \alpha}$$

$$\therefore E_{SO}^1 = \frac{\alpha}{2} \frac{\hbar^3}{2 m^2 c} \cdot \frac{4 E_m^2 m}{\hbar^3 c \alpha} \cdot m \frac{[j(j+1) - l(l+1) - \frac{3}{4}]}{l(l + \frac{1}{2})(l+1)}$$

$$E_{SO}^1 = \frac{E_m^2}{m c^2} m \cdot \frac{[j(j+1) - l(l+1) - \frac{3}{4}]}{l(l + \frac{1}{2})(l+1)}$$

$O(\alpha^4)$

DEPENDS ON  $m, j, l$  !



• TOTAL FINE STRUCTURE CORRECTION

$$E'_{FS} = E'_{rel} + E'_{so}$$

$$= \frac{E_m^2}{2m c^2} \left\{ 3 - \frac{4m}{l + 1/2} \right.$$

$$\left. - \frac{2m}{l + 1/2} + 2m \frac{[j(j+1) - \frac{3}{4}]}{l(l+1)(l + \frac{1}{2})} \right\}$$

↳  $j = l \pm 1/2 \Rightarrow l = j \mp \frac{1}{2}$

$l = j - \frac{1}{2}$  :  $l(l+1)(l + \frac{1}{2}) = (j + \frac{1}{2})(j - \frac{1}{2})j$

$$\{ \} = 3 - \frac{6m}{j} + \frac{2m (j - \frac{1}{2})(j + \frac{3}{2})}{(j + \frac{1}{2})(j - \frac{1}{2})j}$$

$$= 3 - \frac{2m}{j(j + 1/2)} \left[ 3(j + \frac{1}{2}) - (j + \frac{3}{2}) \right]$$

$$= 3 - \frac{4m}{j + 1/2}$$

$$\underline{l = j + \frac{1}{2}} \quad : \quad l(l+1)(l + \frac{1}{2}) = (j + \frac{1}{2})(j + \frac{3}{2})(j+1)$$

$$\{ \} = 3 - \frac{6m}{j+1} + 2m \frac{(j - \frac{1}{2})(j + \frac{3}{2})}{(j + \frac{1}{2})(j + \frac{3}{2})(j+1)}$$

$$= 3 - \frac{2m}{(j + \frac{1}{2})(j+1)} \left[ 3(j + \frac{1}{2}) - (j - \frac{1}{2}) \right]$$

$$2j + 2$$

$$= 3 - \frac{4m}{j + \frac{1}{2}}$$

SAME RESULT!

∴

$$E'_{FS} = E'_{rel} + E'_{SO}$$

$$= \frac{E_m^2}{2mc^2} \cdot \left\{ 3 - \frac{4m}{j + \frac{1}{2}} \right\}$$



DEPENDS ONLY ON m & j !

ex

m = 1  
l = 0 ⇒ j = 1/2

$$E'_{FS} = \frac{E_m^2}{2mc^2} \{-1\}$$

# FINE - STRUCTURE OF H

$H^0$  (BOHR MODEL)

$H^0 + H'_{FS}$   
 $\parallel$   
 $H'_{rel} + H'_{SO}$

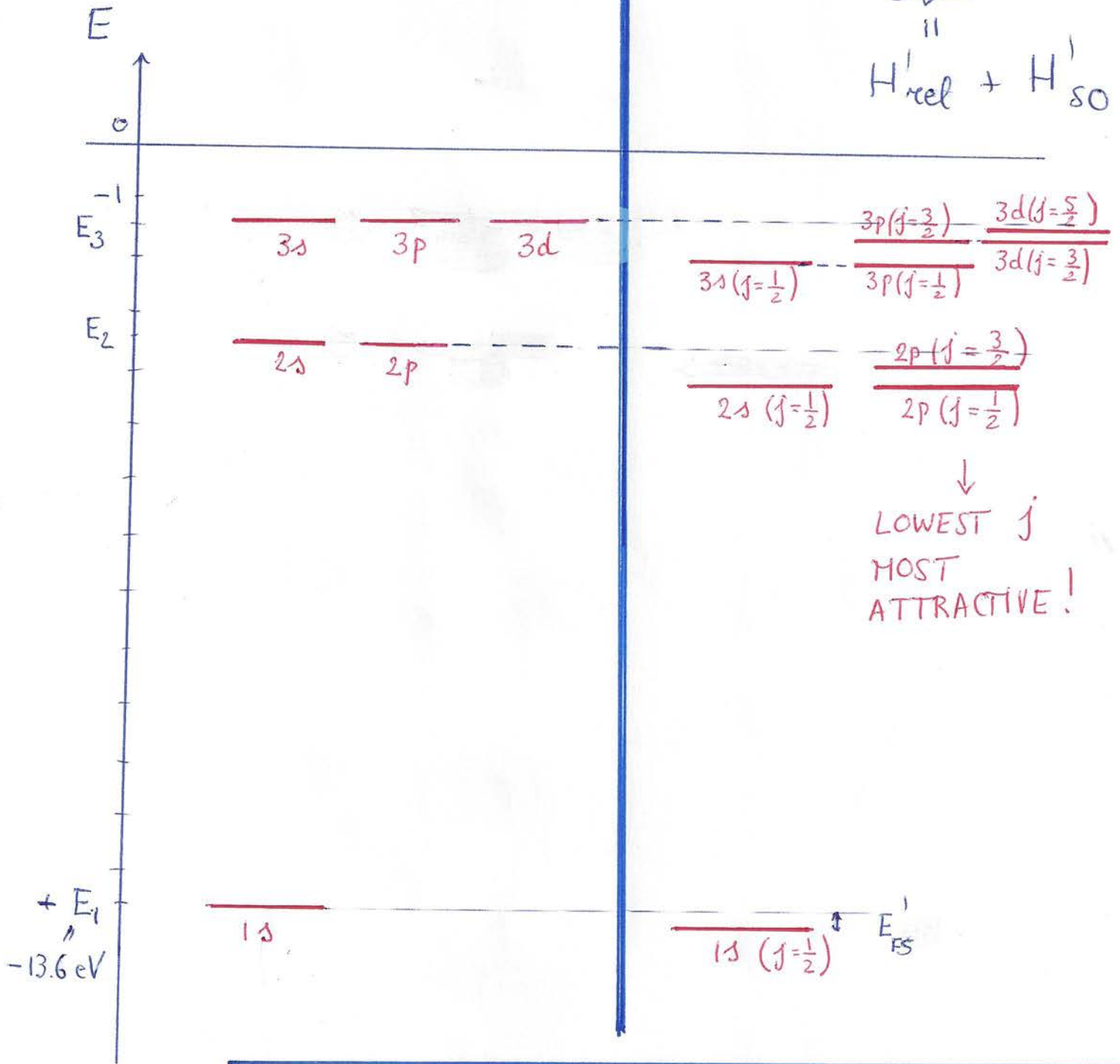

TOTAL  
E

$$E = E_n + E'_{FS} = -\frac{13.6 \text{ eV}}{n^2} \left[ 1 + \frac{\alpha^2}{n^2} \left( \frac{n}{j + \frac{1}{2}} - \frac{3}{4} \right) \right]$$

DEPENDS ON n & j

⇒ ZEEMAN EFFECT (ZEEMAN 1897!)

• ATOM IN EXTERNAL MAGNETIC FIELD  $\vec{B}_{ext}$

$e^-$  ORBITAL MAGN MOMENT  $\vec{\mu}_e$

$e^-$  SPIN MAGN MOMENT  $\vec{\mu}_s$

$$H'_Z = - (\vec{\mu}_e + \vec{\mu}_s) \cdot \vec{B}_{ext}$$

↑  
INTERACTION.  
(ZEEMAN INTERACTION)

$$\vec{\mu}_e = \gamma_e \vec{L}$$

$$\gamma_e = - \frac{e}{2m}$$

$$\vec{\mu}_s = \gamma_s \vec{S}$$

$$\gamma_s = - g \frac{e}{2m}$$

↑  
g-FACTOR.

⇒ DIRAC THEORY  $e^- \xrightarrow{\gamma} e^-$   
 $g = 2$

⇒ QUANTUM ELECTRODYNAMICS

$e^- \xrightarrow{\gamma} e^-$   
 $g = 2.0023$  } VACUUM FLUCTUATION CORRECTIONS

11 DIGITS !

EXPERIMENT:  $g = 2.0023193043718 \pm 0.00000000000076$



FOR  $g = 2$

6.44

$$H'_Z = \frac{e}{2m} (\bar{L} + 2\bar{S}) \cdot \bar{B}_{\text{ext}}$$

↳ 3 POSSIBLE REGIMES

① IF  $H'_Z$  IS A PERTURBATION COMPARED TO  $H'_{\text{FS}}$

$$B_{\text{ext}} \ll B_{\text{int}}$$

↳ INTERNAL MAGN FIELD DUE TO ORBITAL MOTION OF  $e^-$  RELATIVE TO  $p$

$$\bar{B}_{\text{int}} = \frac{e}{4\pi\epsilon_0 c^2} \cdot \frac{1}{m_e} \bar{L}$$

WEAK FIELD ZEEMAN EFFECT

② IF  $B_{\text{int}} \ll B_{\text{ext}}$

TREAT  $H'_{\text{FS}}$  AS PERTURBATION TO  $H'_Z$

③ IF  $B_{\text{int}} \approx B_{\text{ext}}$

APPLY DEGENERATE PERT. THEORY

↳ DIAGONALIZE HAMILTONIAN

# WEAK FIELD ZEEMAN EFFECT

↳  $H'_Z \ll H'_{FS}$

GOOD UNPERTURBED STATES

$|m_l s j m_j\rangle$

GOOD QUANTUM NUMBERS FOR  $H'_{FS}$   
↑  
COMMUTES WITH  $J^2, J_z$

↳  $E'_Z = \langle m_l s j m_j | H'_Z | m_l s j m_j \rangle$

$= \frac{e}{2m} \bar{B}_{ext} \cdot \langle m_l s j m_j | \bar{L} + 2\bar{S} | m_l s j m_j \rangle$

↓  $\bar{J} = \bar{L} + \bar{S}$

$= \frac{e}{2m} \bar{B}_{ext} \cdot \langle m_l s j m_j | \bar{J} + \bar{S} | m_l s j m_j \rangle$

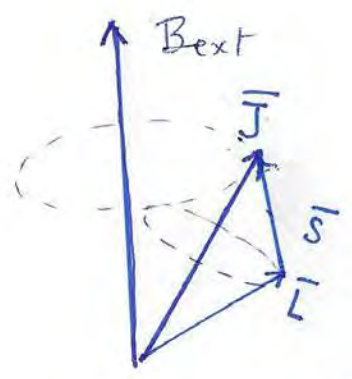

$\bar{J}$  PRECESSES AROUND  $B_{ext}$  :  $\omega_1 \sim B_{ext}$   
 $\bar{L}, \bar{S}$  PRECESS AROUND  $\bar{J}$  :  $\omega_2 \sim B_{int}$   
FOR  $B_{int} \gg B_{ext}$   $\omega_2 \gg \omega_1$

FOR  $\omega_2 \gg \omega_1$ ,

WE CAN REPLACE  $\bar{S}$  BY ITS TIME AVERAGE

PROJECTION ALONG  $\bar{J}$

$$\bar{S}_{av} = \frac{(\bar{S} \cdot \bar{J})}{J^2} \bar{J}$$

$$E'_z \approx \frac{e}{2m} \bar{B}_{ext} \cdot \langle n l j m_j | \left( 1 + \frac{\bar{S} \cdot \bar{J}}{J^2} \right) \bar{J} | n l j m_j \rangle$$

$$L^2 = (\bar{J} - \bar{S})^2$$
$$= J^2 + S^2 - 2 \bar{J} \cdot \bar{S}$$

$$\bar{S} \cdot \bar{J} = \frac{1}{2} (J^2 - L^2 + S^2)$$

$$\langle n l j m_j | \bar{S} \cdot \bar{J} | n l j m_j \rangle = \frac{\hbar^2}{2} [j(j+1) - l(l+1) + \frac{3}{4}]$$

$$E'_z \approx \frac{e}{2m} \cdot \left[ 1 + \frac{j(j+1) - l(l+1) + 3/4}{2 j(j+1)} \right]$$
$$\bar{B}_{ext} \cdot \langle n l j m_j | \bar{J} | n l j m_j \rangle$$



CHOOSE z-AXIS ALONG  $\vec{B}_{ext} = B_{ext} \hat{e}_z$

$\leadsto \langle n l j m_j | \bar{J}_z | n l j m_j \rangle = \hbar m_j$

$\leadsto$  INTRODUCE BOHR MAGNETON

$$\mu_B \equiv \frac{e \hbar}{2 m} \approx 5.79 \times 10^{-5} \frac{eV}{T}$$

$$E'_Z \approx \mu_B \cdot g_j \cdot B_{ext} \cdot m_j$$

↑  
LANDE g - FACTOR

$$g_j \equiv 1 + \frac{j(j+1) - l(l+1) + 3/4}{2 j(j+1)}$$

$E'_Z = - \langle \vec{\mu}_j \rangle \cdot \vec{B}_{ext}$  DEFINES A MAGN. MOMENT  $\vec{\mu}_j$  ASSOCIATED WITH  $\vec{J}$

$$\mu_j = - \frac{e}{2m} \cdot g_j \cdot J_z$$

↑  
z-COMPONENT OF  $\vec{\mu}_j$



↳ GRAPHICALLY

⇒  $n=1, l=0, j=\frac{1}{2}, m_j = \pm \frac{1}{2}$  ( H-ATOM GROUND STATE )

$g_{\frac{1}{2}} = 2$

SPLITS IN 2!

$E_Z \approx \pm \mu_B B_{ext}$

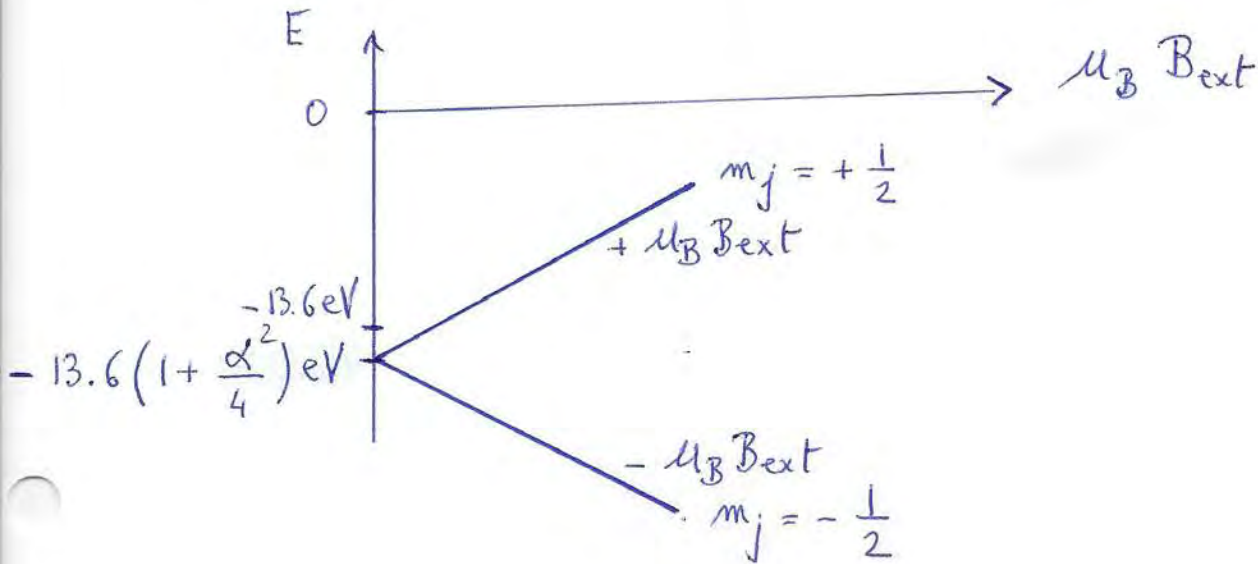

⇒  $n=2, l=1, j=\frac{3}{2}, m_j = -\frac{3}{2}, -\frac{1}{2}, +\frac{1}{2}, +\frac{3}{2}$

SPLITS IN 4!

$g_{\frac{3}{2}} = \frac{4}{3}$

$E_Z = \mu_B B_{ext} \frac{4}{3} m_j$

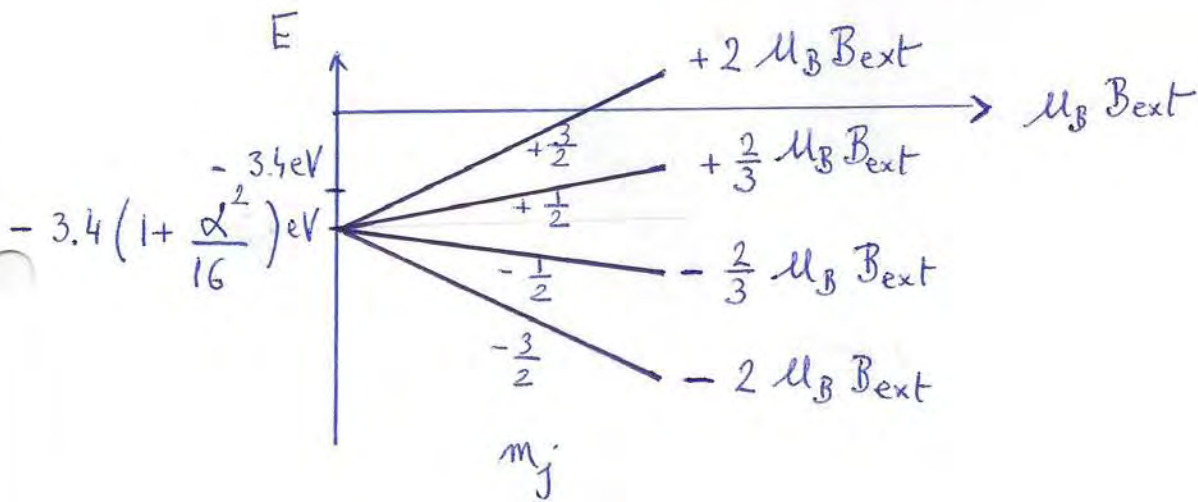

## • STRONG FIELD ZEEMAN EFFECT

↳ ALSO KNOWN AS PASCHEN-BACK EFFECT

$$B_{\text{ext}} \gg B_{\text{int}}$$

$$H'_Z \gg H'_{\text{FS}}$$

GOOD QUANTUM NUMBERS  $n, l, m_l, m_s$

$$H'_Z = \frac{e}{2m} B_{\text{ext}} (L_z + 2S_z)$$

CHOOSE z-AXIS ALONG  $\vec{B}_{\text{ext}}$ .

$$E'_{nlm_l m_s} = \langle nlm_l m_s | H'_Z | nlm_l m_s \rangle$$

$$E'_{nlm_l m_s} = \mu_B B_{\text{ext}} (m_l + 2m_s)$$

↳  $H'_{\text{FS}}$  TREATED AS PERTURBATION.

$$H'_{\text{SO}} = \frac{1}{2} \alpha \frac{\hbar}{c} \frac{1}{m^2 r^3} \vec{L} \cdot \vec{S}$$

REPLACE

$$\langle \bar{L} \cdot \bar{S} \rangle \approx \langle L_x \rangle \langle S_x \rangle + \langle L_y \rangle \langle S_y \rangle + \langle L_z \rangle \langle S_z \rangle$$

$\begin{matrix} \text{"} & \text{"} & \text{"} & \text{"} \\ 0 & 0 & 0 & 0 \end{matrix}$

$$= \hbar^2 m_l m_s$$

$$E'_{FS} = \frac{E_n^2}{2mc^2} \left\{ \underbrace{3 - \frac{4m}{l + \frac{1}{2}}}_{\text{REL. CORR.}} + \frac{4m m_l m_s}{l(l + \frac{1}{2})(l + 1)} \right\}$$

$$E'_{FS} = \frac{(13.6) \text{ eV}}{n^3} \left\{ \frac{3}{4m} - \frac{l(l+1) - m_l m_s}{l(l + \frac{1}{2})(l + 1)} \right\}$$

FINE-STRUCTURE CORR.

IN CASE OF STRONG EXT. FIELD

# INTERMEDIATE FIELD ZEEMAN EFFECT

WHEN  $B_{int} \approx B_{ext}$

TREAT  $H'_{FS}$  &  $H'_Z$  ON EQUAL FOOTING

↳ APPLY DEGENERATE PERTURBATION THEORY

IN UNPERTURBED BASIS  $|n l j m_j\rangle$

$$W_{ij} = \langle \mathcal{N}_i^0 | H'_{FS} + H'_Z | \mathcal{N}_j^0 \rangle$$

$$|\mathcal{N}_i^0\rangle = |n l j m_j\rangle$$

$$\hookrightarrow \langle n l j m_j | H'_{FS} | n' l' j' m_j' \rangle$$

$$= \delta_{nn'} \delta_{ll'} \delta_{jj'} \delta_{m_j m_j'} \frac{E_n^2}{2mc^2} \left\{ 3 - \frac{4m}{j + \frac{1}{2}} \right\}$$

(WAS DONE ABOVE)  $\rightarrow$  DIAGONAL

$$\hookrightarrow \langle n l j m_j | H'_Z | n' l' j' m_j' \rangle$$

$$= \frac{e}{2m} B_{ext} \langle n l j m_j | L_z + 2S_z | n l j m_j \rangle$$

EXPRESS

CLEBSCH-GORDON COEFF.

$$|n l j m_j\rangle = \sum_{m_l m_s} \langle l m_l, \frac{1}{2} m_s | j m_j \rangle |n l m_l\rangle | \frac{1}{2} m_s \rangle$$





$$\hookrightarrow \langle \Psi_1^0 | L_z + 2S_z | \Psi_1^0 \rangle = + \hbar$$

$$\langle \Psi_2^0 | L_z + 2S_z | \Psi_2^0 \rangle = - \hbar$$

NON-DIAGONAL ME INVOLVING 1 & 2  $\rightarrow 0$

$$\hookrightarrow \langle \Psi_3^0 | L_z + 2S_z | \Psi_3^0 \rangle = \hbar (1 + 1) = 2\hbar$$

$$\langle \Psi_4^0 | L_z + 2S_z | \Psi_4^0 \rangle = \hbar (-1 - 1) = -2\hbar$$

$$\begin{aligned} \langle \Psi_5^0 | L_z + 2S_z | \Psi_5^0 \rangle &= \hbar \left\{ \frac{2}{3} (0 + 1) + \frac{1}{3} (1 - 1) \right\} \\ &= \hbar \frac{2}{3} \end{aligned}$$

$$\begin{aligned} \langle \Psi_6^0 | L_z + 2S_z | \Psi_6^0 \rangle &= \hbar \left\{ \frac{1}{3} (0 + 1) + \frac{2}{3} (1 - 1) \right\} \\ &= \hbar \frac{1}{3} \end{aligned}$$

$$\langle \Psi_7^0 | L_z + 2S_z | \Psi_7^0 \rangle = - \hbar \frac{2}{3}$$

$$\langle \Psi_8^0 | L_z + 2S_z | \Psi_8^0 \rangle = - \hbar \frac{1}{3}$$

NON-DIAG. : ONLY BETWEEN  $\Psi_5^0$  &  $\Psi_6^0$   
 $\Psi_7^0$  &  $\Psi_8^0$

ARE NON-ZERO

$$\begin{aligned} \langle \Psi_5^0 | L_z + 2S_z | \Psi_6^0 \rangle &= \hbar \left\{ - \frac{\sqrt{2}}{3} (0 + 1) + \frac{\sqrt{2}}{3} (1 - 1) \right\} \\ &= - \hbar \frac{\sqrt{2}}{3} \end{aligned}$$

$$\langle \Psi_7^0 | L_z + 2S_z | \Psi_8^0 \rangle = \hbar \left\{ \frac{\sqrt{2}}{3} (0 - 1) - \frac{\sqrt{2}}{3} (-1 + 1) \right\} = - \hbar \frac{\sqrt{2}}{3}$$

↳  $\beta \equiv \mu_B B_{ext} = \left(\frac{e\hbar}{2m}\right) B_{ext}$

↳  $\langle \underset{\substack{\uparrow \\ m}}{2} \underset{\substack{\uparrow \\ l}}{1} j m_j | H'_{FS} | \underset{\substack{\uparrow \\ m}}{2} \underset{\substack{\uparrow \\ l}}{1} j m_j \rangle$   
 $= \frac{(13.6 \text{ eV})}{2^4} \frac{\frac{1}{2} mc^2}{2mc^2} \alpha^2 \left\{ 3 - \frac{8}{j + \frac{1}{2}} \right\}$

$= \underbrace{\left(\frac{\alpha}{8}\right)^2 (13.6 \text{ eV})}_{\text{III } \gamma} \cdot \underbrace{\left\{ 3 - \frac{8}{j + \frac{1}{2}} \right\}}_{\substack{j = \frac{3}{2} \leftarrow \\ j = \frac{1}{2} \leftarrow \\ -1 \quad -5}}$

W = -

5γ - β	0	0	0	0	0	0	0	0
0	5γ + β	0	0	0	0	0	0	0
0	0	γ - 2β	0	0	0	0	0	0
0	0	0	γ + 2β	0	0	0	0	0
0	0	0	0	γ - $\frac{2\beta}{3}$	$\frac{\sqrt{2}\beta}{3}$	0	0	0
0	0	0	0	$\frac{\sqrt{2}\beta}{3}$	5γ - $\frac{1}{3}\beta$	0	0	0
0	0	0	0	0	0	γ + $\frac{2\beta}{3}$	$\frac{\sqrt{2}\beta}{3}$	0
0	0	0	0	0	0	$\frac{\sqrt{2}\beta}{3}$	5γ + $\frac{1}{3}\beta$	0

↓  
DIAGONALIZE W

• 4 EIGENVALUES

$$\begin{cases} E_1' = -(5\gamma - \beta) \\ E_2' = -(5\gamma + \beta) \\ E_3' = -(\gamma - 2\beta) \\ E_4' = -(\gamma + 2\beta) \end{cases}$$

• DIAGONALIZE TWO 2x2 MATRICES.

$$\begin{vmatrix} \gamma - \frac{2}{3}\beta + \lambda & \frac{\sqrt{2}}{3}\beta \\ \frac{\sqrt{2}}{3}\beta & 5\gamma - \frac{1}{3}\beta + \lambda \end{vmatrix} = 0$$

$$\lambda^2 + (6\gamma - \beta)\lambda + (5\gamma^2 - \frac{11}{3}\beta\gamma) = 0$$

$$\parallel E_{5,6}' = \left(\frac{\beta}{2} - 3\gamma\right) \pm \sqrt{4\gamma^2 + \frac{2}{3}\beta\gamma + \frac{\beta^2}{4}} \parallel$$

•

$$\begin{vmatrix} \gamma + \frac{2}{3}\beta + \lambda & \frac{\sqrt{2}}{3}\beta \\ \frac{\sqrt{2}}{3}\beta & 5\gamma + \frac{1}{3}\beta + \lambda \end{vmatrix} = 0$$

$$\lambda^2 + (6\gamma + \beta)\lambda + (5\gamma^2 + \frac{11}{3}\beta\gamma) = 0$$

$$\parallel E_{7,8}' = \left(-\frac{\beta}{2} - 3\gamma\right) \pm \sqrt{4\gamma^2 - \frac{2}{3}\beta\gamma + \frac{\beta^2}{4}} \parallel$$



↳ SPECIAL CASES

- $\beta = 0$  : NO EXTERNAL FIELD

$$E_1' = E_2' = E_6' = E_8' = -5\gamma \quad (j = \frac{1}{2})$$

$$E_3' = E_4' = E_5' = E_7' = -\gamma \quad (j = \frac{3}{2})$$

⇓

RESULTS FROM  $H_{FS}'$

- $\beta \ll \gamma$  WEAK EXTERNAL FIELDS

$$E_1' = -5\gamma + \beta$$

$$E_2' = -5\gamma - \beta$$

$$E_3' = -\gamma + 2\beta$$

$$E_4' = -\gamma - 2\beta$$

$$E_5' = -\gamma + \frac{2}{3}\beta$$

$$E_6' = -5\gamma + \frac{1}{3}\beta$$

$$E_7' = -\gamma - \frac{2}{3}\beta$$

$$E_8' = -5\gamma - \frac{1}{3}\beta$$

NOTE:  $\sqrt{4\gamma^2 + \frac{2}{3}\beta\gamma + \frac{\beta^2}{4}} \approx 2\gamma \left(1 + \frac{\beta}{12\gamma}\right)$

$$\rightsquigarrow g_J = \frac{2}{3}$$

$$= 2\gamma + \frac{\beta}{6}$$

↳ FIND BACK RESULTS OF WEAK FIELD ZEEMAN EFFECT

- $\beta \gg \gamma$  → FIND BACK RESULTS OF STRONG FIELD ZEEMAN EFFECT

- $\beta \gg \gamma$       STRONG EXTERNAL FIELDS

$$E'_1 = -5\gamma + \beta$$

$$E'_2 = -5\gamma - \beta$$

$$E'_3 = -\gamma + 2\beta$$

$$E'_4 = -\gamma - 2\beta$$

$$E'_5 \approx \frac{\beta}{2} - 3\gamma + \frac{\beta}{2} \sqrt{1 + \frac{8}{3} \frac{\gamma}{\beta}}$$

$$\approx 1 + \frac{4}{3} \frac{\gamma}{\beta}$$

$$= \beta - \frac{7}{3} \gamma$$

$$E'_6 \approx \frac{\beta}{2} - 3\gamma - \frac{\beta}{2} \left( 1 + \frac{4}{3} \frac{\gamma}{\beta} \right)$$

$$\approx 0 - \frac{11}{3} \gamma$$

$$E'_7 \approx -\frac{\beta}{2} - 3\gamma + \frac{\beta}{2} \left( 1 - \frac{4}{3} \frac{\gamma}{\beta} \right)$$

$$\approx 0 - \frac{11}{3} \gamma$$

$$E'_8 \approx -\beta - \frac{7}{3} \gamma$$

FOR  $\beta \gg \gamma$  (5 LEVELS)

$$\left\| \begin{array}{ll} E'_1 = E'_5 = \beta & E'_3 = 2\beta \\ E'_2 = E'_8 = -\beta & E'_4 = -2\beta \end{array} \right. \quad E'_6 = E'_7 = 0$$

$$\hat{H}_0$$

$$\hat{H}_0 + \hat{H}_{FS}$$

$$\hat{H}_0 + \hat{H}_{FS} + \hat{H}_Z$$

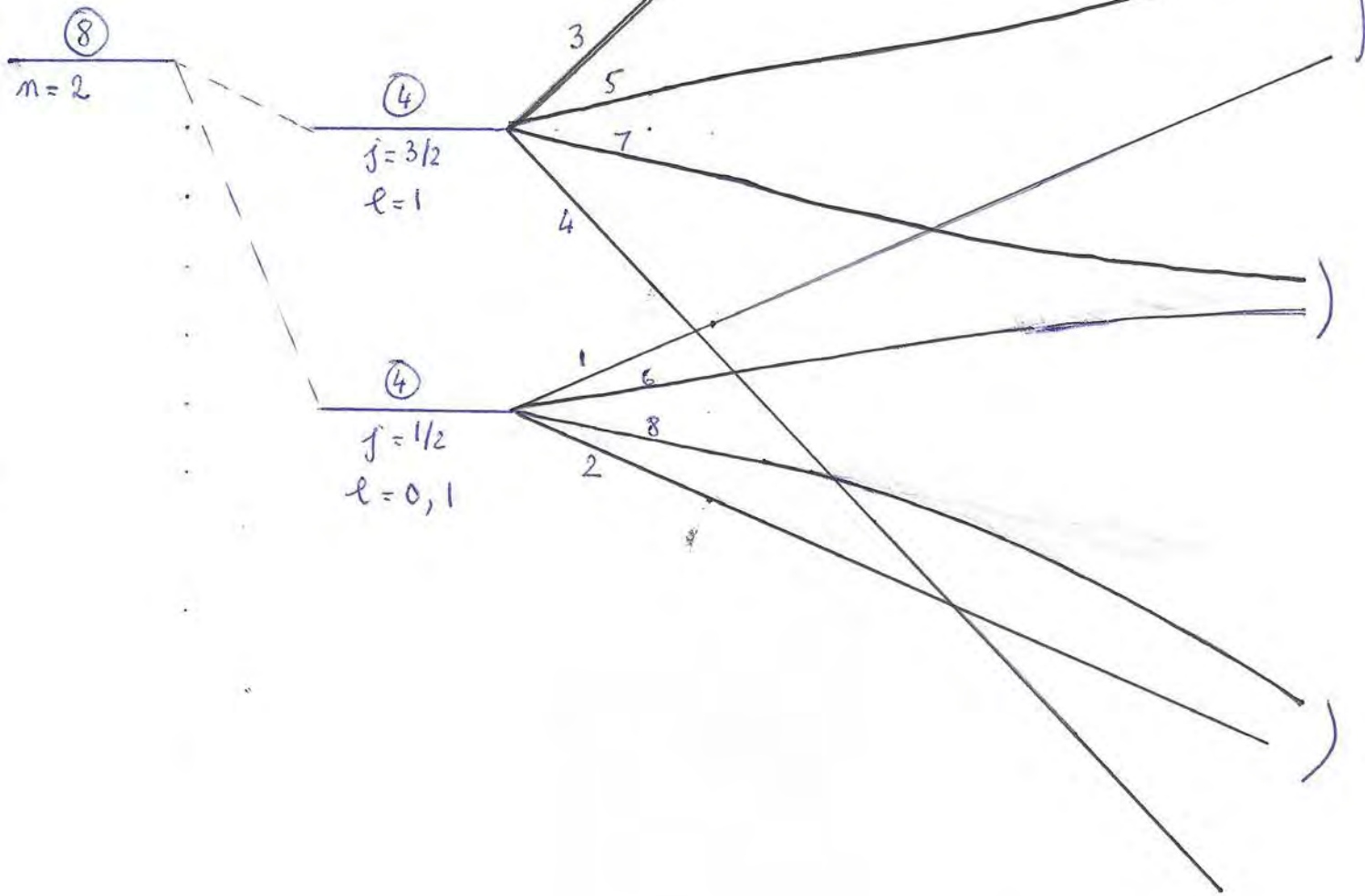

## ⇒ HYPERFINE SPLITTING IN H

- ZERO RANGE INTERACTION BETWEEN 2 MAGNETIC DIPOLE MOMENTS  $\vec{\mu}_1$  &  $\vec{\mu}_2$

$$\hat{H} = -\frac{2}{3} \mu_0 \vec{\mu}_1 \cdot \vec{\mu}_2 \delta^3(\vec{r})$$

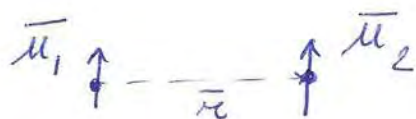

(see E & M : MAGNETOSTATICS)

- **SPIN-SPIN INTERACTION** BETWEEN  $e^-$  SPIN & PROTON SPIN IN HYDROGEN

$$\vec{\mu}_e = -g_e \frac{e}{2m_e} \vec{S}_e, \quad g_e = 2$$

$$\vec{\mu}_p = +g_p \frac{e}{2m_p} \vec{S}_p, \quad g_p = 5.58$$

NOTE  $m_e \approx 0.511 \text{ MeV}$   
 $m_p \approx 938.3 \text{ MeV}$

$$\frac{m_e}{m_p} \approx \frac{1}{2000}$$



$$\hat{H}_{HF} = + \frac{1}{3} \mu_0 \frac{e^2 g_p}{m_e m_p} \bar{S}_e \cdot \bar{S}_p \delta^3(\vec{r})$$

↑  
HYPERFINE  
INTERACTION

IN  $l=0$  STATE OF HYDROGEN

↑  
SPIN-SPIN  
INTERACTION

$$\bar{S}_e \cdot \bar{S}_p = \frac{1}{2} (S^2 - S_e^2 - S_p^2)$$

$$\begin{array}{ccc} \uparrow & \uparrow e^- & S=1 \\ \uparrow & \downarrow e^- & S=0 \end{array} \Rightarrow \langle \bar{S}_e \cdot \bar{S}_p \rangle = \frac{\hbar^2}{2} \cdot \left(2 - \frac{3}{2}\right)$$

$$= \frac{\hbar^2}{4}$$

$$\Rightarrow \langle \bar{S}_e \cdot \bar{S}_p \rangle = \frac{\hbar^2}{2} \left(-\frac{3}{2}\right)$$

$$= -\frac{3\hbar^2}{4}$$

$$\langle \delta^3(\vec{r}) \rangle = \frac{1}{\pi a^3} \quad \text{FOR } m=1$$

$$= |N_{100}(0)|^2 \quad \underline{\underline{l=0}}$$

$$E_{HF}^1 (m=1, l=0) = \frac{\mu_0}{3} \frac{e^2 g_p}{\pi a^3 m_e m_p} \cdot \hbar^2 \cdot \begin{cases} +\frac{1}{4} & (S=1) \\ -\frac{3}{4} & (S=0) \end{cases}$$

$$\Rightarrow \mu_0 \frac{e^2}{\pi} = \frac{e^2}{\pi \epsilon_0 c^2} = 4\alpha \frac{\hbar}{c} \quad (\alpha = \frac{1}{137})$$

6.59

$$\Rightarrow a = \frac{1}{m_e \alpha} \frac{\hbar}{c}$$

$$\Rightarrow -E_1 = \alpha^2 \frac{1}{2} m_e c^2$$

$$\frac{1}{a^3} = m_e^3 \alpha^3 \frac{c^3}{\hbar^3}$$

$$\Rightarrow E'_{HF} (n=1, l=0) = \frac{4}{3} \alpha^4 g_P \frac{m_e^2 c^2}{m_p} \cdot \begin{cases} 1/4 (S=1) \\ -3/4 (S=0) \end{cases}$$

$$= (-E_1) \cdot \alpha^2 \frac{m_e}{m_p} \frac{8}{3} g_P \begin{cases} 1/4 (S=1) \\ -3/4 (S=0) \end{cases}$$

$\underbrace{\hspace{1.5cm}}_{13.6 \text{ eV}} \quad \underbrace{\hspace{1.5cm}}_{\sim 10^{-4}} \quad \underbrace{\hspace{1.5cm}}_{\sim 10^{-3}}$

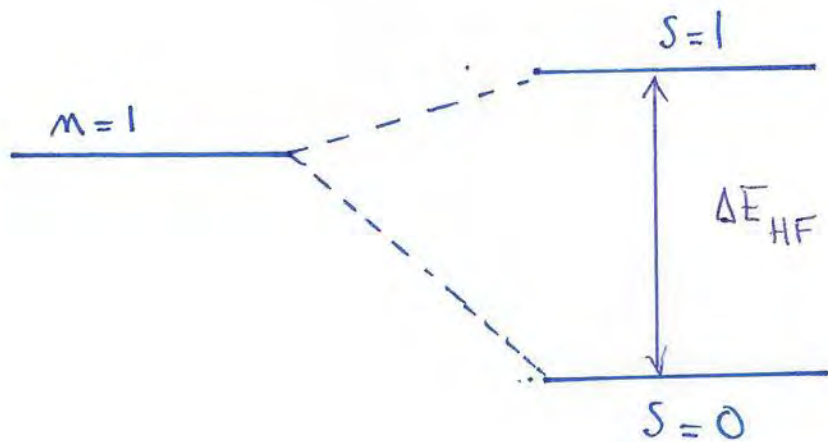

$$\Delta E_{\text{HF}} = (-E_1) \cdot \alpha^2 \frac{m_e}{m_p} \frac{8}{3} g_p$$

$$\Delta E_{\text{HF}} \approx 5.88 \cdot 10^{-6} \text{ eV}$$

$$\Delta E_{\text{HF}} = h \nu$$

$$= \frac{hc}{\lambda}$$

$$\lambda = \frac{hc}{\Delta E_{\text{HF}}} = \frac{(197 \text{ eV} \cdot 10^{-9} \text{ m})}{5.88 \cdot 10^{-6} \text{ eV}}$$

$$\approx 21 \cdot 10^{-2} \text{ m}$$

$$\lambda = 21 \text{ cm}$$



21 cm line in RADIO ASTRONOMY!

EMITTED BY H-GAS IN  
INTERSTELLAR REGION

# The Hydrogen 21-cm Line

The hydrogen in our galaxy has been mapped by the observation of the 21-cm wavelength line of hydrogen gas. At 1420 MHz, this radiation from hydrogen penetrates the dust clouds and gives us a more complete map of the hydrogen than that of the stars themselves since their visible light won't penetrate the dust clouds.

The 1420 MHz radiation comes from the transition between the two levels of the hydrogen 1s ground state, slightly split by the interaction between the electron spin and the nuclear spin. The splitting is known as hyperfine structure. Because of the quantum properties of radiation, hydrogen in its lower state will absorb 1420 MHz and the observation of 1420 MHz in emission implies a prior excitation to the upper state.

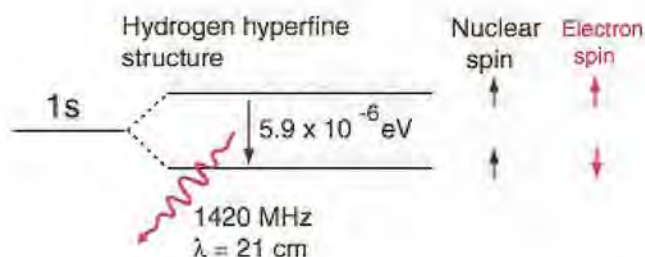

This splitting of the hydrogen ground state is extremely small compared to the ground state energy of  $-13.6 \text{ eV}$ , only about two parts in a million. The two states come from the fact that both the electron and nuclear spins are  $1/2$  for the proton, so there are two possible states, spin parallel and spin antiparallel. The state with the spins parallel is slightly higher in energy (less tightly bound).

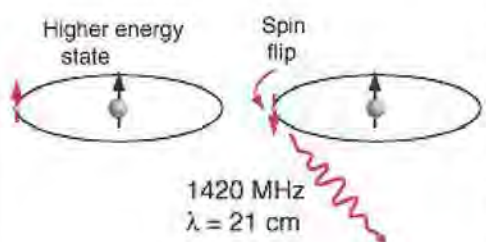

In visualizing the transition as a spin-flip, it should be noted that the quantum mechanical property called "spin" is not literally a classical spinning charge sphere. It is a description of the behavior of quantum mechanical angular momentum and does not have a definitive classical analogy.

The observation of the 21cm line of hydrogen marked the birth of spectral-line radio astronomy. It was first observed in 1951 by Harold Ewen and Edward M. Purcell at Harvard, followed soon afterward by observers in Holland and Australia. The prediction that the 21 cm line should be observable in emission was made in 1944 by Dutch astronomer H. C. van de Hulst.

[Index](#)

[Hydrogen concepts](#)

[Reference Harwit.](#)



# Astronomy Picture of the Day

Discover the cosmos! Each day a different image or photograph of our fascinating universe is featured, along with a brief explanation written by a professional astronomer.

December 18, 1996

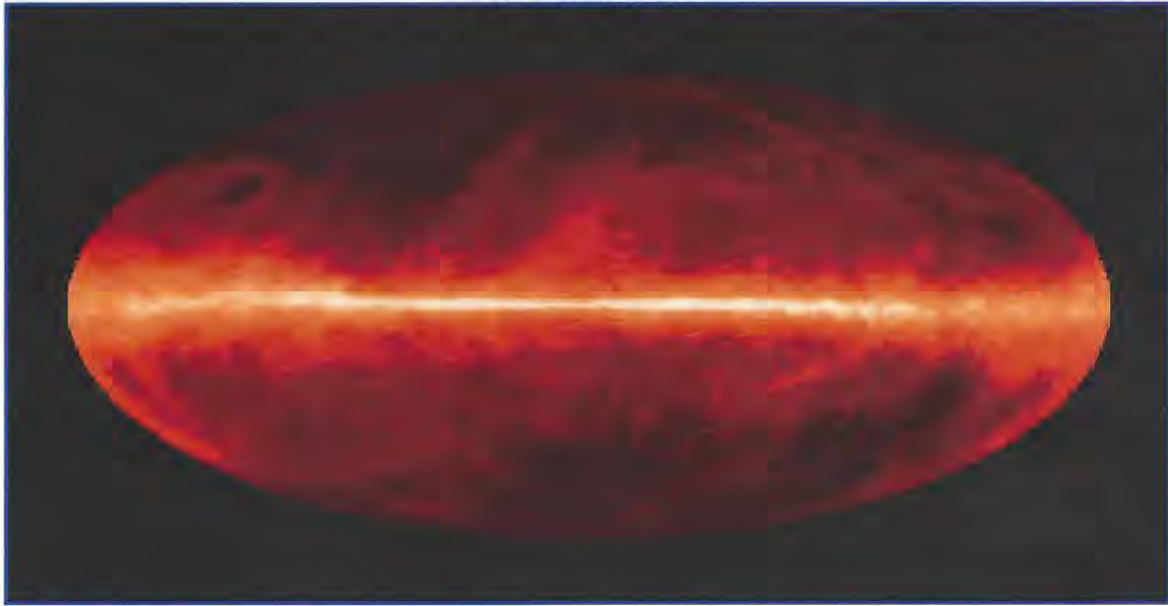

## A Sky Full Of Hydrogen

Credit: J. Dickey ([UMn](#)), F. Lockman ([NRAO](#)), [SkyView](#)

**Explanation:** Interstellar space is filled with extremely tenuous clouds of gas which are mostly Hydrogen. The neutral hydrogen atom (HI in astronomer's shorthand) consists of 1 proton and 1 electron. The proton and electron spin like tops but can have only two orientations; spin axes parallel or anti-parallel. It is a rare event for Hydrogen atoms in the interstellar medium to switch from the parallel to the anti-parallel configuration, but when they do they emit radio waves with a wavelength of 21 centimeters (about 8 inches) and a corresponding frequency of exactly 1420 MHz. Tuned to this frequency radio telescopes have mapped the neutral Hydrogen in the sky. The above image represents such an all-sky HI survey with the plane of our Milky Way Galaxy running horizontally through the center. In this false color image no stars are visible, just diffuse clouds of gas tens to hundreds of light years across which cluster near the plane. The gas clouds seem to form arching, looping structures, stirred up by stellar activity in the galactic disk.

Tomorrow's picture: [Comet Hale-Bopp Inbound](#)

---

[< Archive](#) | [Index](#) | [Search](#) | [Glossary](#) | [Education](#) | [About APOD](#) >

---

**Authors & editors:** [Robert Nemiroff \(MTU\)](#) & [Jerry Bonnell \(USRA\)](#)

NASA Technical Rep.: [Jay Norris](#). Specific rights apply.

A service of: [LHEA](#) at [NASA/ GSFC](#)